

LE401-M12

Material

PPA - Polyphthalamide
(PA hex nut)

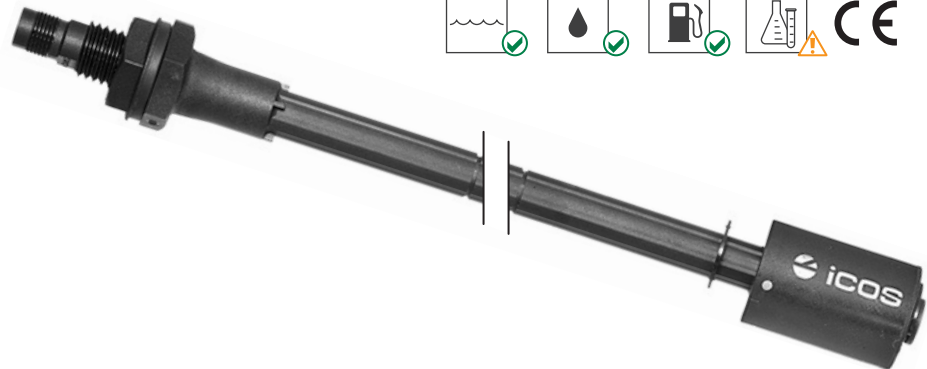

How it works Movement of the magnetic float opens/closes a hermetically sealed contact (reed switch).

- Details**
- 400mm length;
 - On/Off SPST output;
 - Work as normally open or normally closed, by inverting float position;
 - M12 output connection.

- Typical applications**
- Tank liquid level control in 1 point;
 - Pumps automation;
 - Machine tools.



Chemical products require preliminary tests to confirm compatibility.
Liquid with ferrous particles should be avoided.

Technical specifications

Maximum operating pressure	2bar
Operating temperature range	-10°C to 90°C
Liquid minimum density (SG)	0.70
Sealing	NBR gasket
Output connection	M12 male plug (2 pins) M12 female connector NOT included
Enclosure rating	IP66
Electrical contact	Reed Switch 20W/VA

The sensors work in all voltage and current ranges displayed in the table below:

Operating Voltage	Max. Switching Power	Max. Switching Current	Peak Current
110Vac	20VA	0.2A	0.5A @20ms
220Vac	20VA	0.1A	0.5A @20ms
5Vdc	2.5W	0.5A	1A @20ms
12Vdc	5W	0.5A	1A @20ms
24Vdc	10W	0.5A	1A @20ms

24Vac: NOT recommended

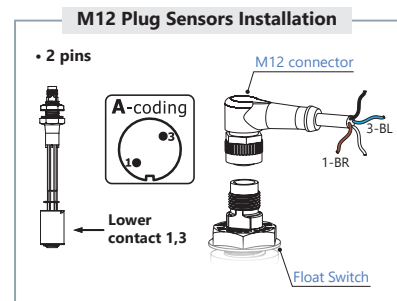

Important!

- For cables longer than 20 meters.
- Relay coupler, timing relay, frequency inverter.

A series **resistor** must be installed.
[Click and check how to install.](#)

Dimensions (mm) and Weight

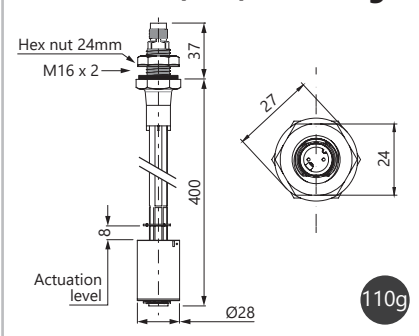

Mounting

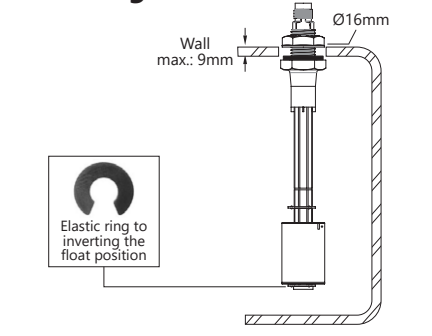

Typical connection to contactor

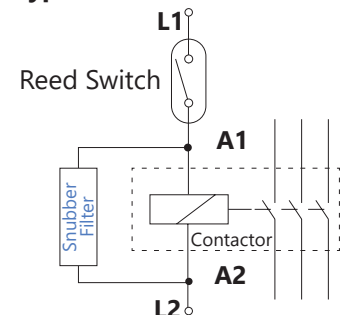

level sensor | level switch | float level | float switch | magnetic level switch | liquid level controller

[Click and Check:](#)
[Models and Prices](#) | [Datasheets](#) | [Operation Videos](#)

Flow Switches and Level Switches for liquids