

Operation

- **Liquids with solid particles and/or fouling** require prior testing. Use filter before the Sensor to prevent the internal piston from locking. Not recommended for industrial water waste.
- **Liquids with ferrous and/or magnetic particles** require technical analysis: the Sensor contains magnetic components inside. Use a magnetic filter before the Sensor to avoid deposition/settling that will prejudice its operation.

Typical Connection to Contactor

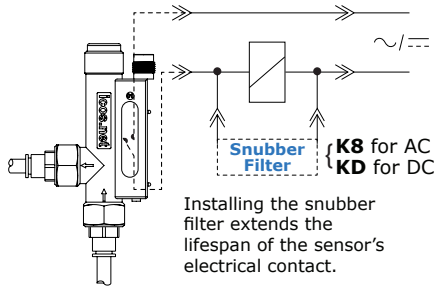

! Never connect the sensor directly to a motor, pump, lamp or any other load over 20W. Always use a contactor or relay.



Installing the snubber filter extends the lifespan of the sensor's electrical contact.

The sensors work in all voltage and current ranges displayed in the table below:

Operating Voltage	Max. Switching Power	Max. Switching Current	Peak Current
110Vac	20VA	0.2A	0.5A @20ms
220Vac	20VA	0.1A	0.5A @20ms
5Vdc	2.5W	0.5A	1A @20ms
12Vdc	5W	0.5A	1A @20ms
24Vdc	10W	0.5A	1A @20ms

24Vac: NOT recommended

Term of Warranty

For installations according to this guide: 02 (two) years warranty. **Incorrect installation cancels the warranty.** All Sensors have been tested and approved during the manufacture process.

On datasheets.icos.us available technical specifications

+55 (15) 3032.9190

Electrical Contact of Sensors - Attention to Install

Reed Switch 20W/VA: Protect the Electrical Contact of your Sensor



Reed Switches are hermetically sealed contacts actuated by a magnetic field.

The life expectancy of a reed switch refers to a kind of load to be used. Reed Switches of the highest reliability are applied in our sensors, and their life expectancy can reach above two million operations. However, when they are switching lamps, inductive or capacitive loads, this number may decrease.

Switching Power

It is important to consider that the power specified by an electrical load is often referred to the permanent working state.

For higher power, use an auxiliary relay or contactor as recommended below, or similar.

Siemens 3RT1015 Contactor

Initial: 31.7VA
Rated: 5.1VA

Note: Reed Switches have reached over one million operations in tests with contactor and K8* snubber filter.

*On accessories.icos.us check models and prices of Filters and Mini Contactor

Flow Switches

Models for G 1/4" Port



IMPORTANT !
YOU MUST CHECK BEFORE INSTALLATION

Questions? Call us **BEFORE** you install:

+55 (15) 3032.9190

levelsensor.icos.us | datasheets.icos.us | videos.icos.us

Follow the instructions below to protect and extend the shelf life of the sensor:

- **AUXILIARY CONTACTOR (mini contactor) mind the distance:**



- **SOLENOID VALVE or POWER CONTACTOR:**

Use *mini contactor* or *auxiliary relay*.

- **ELECTRONIC EQUIPMENT:**

> Interface relay/relay coupler: Use **4K7 10W resistor**.
> Timing relay and frequency inverter: Use **220R 5W* resistor**.

AC Current: Use **K8 Filter*** in parallel with the coil (A1 A2) of a contactor or relay.
DC Current: Use **KD Filter*** in parallel with the coil (A1 A2) of a contactor or relay.

*For sale on accessories.icos.us

PROTECTION PROCEDURES BELOW DESCRIBED CAN IMPROVE THE REED SWITCH PERFORMANCE

- Switching inductive loads

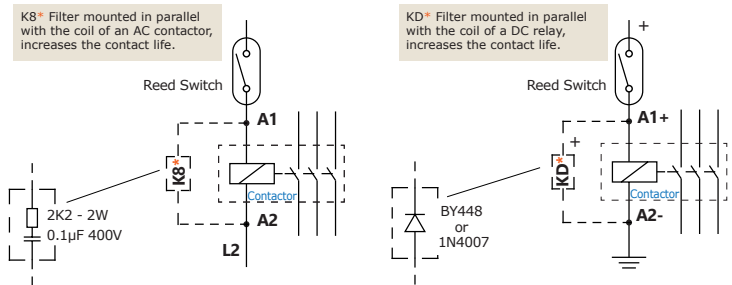

? **Risk of failure (welding of the Reed Switch Contact)** due to CAPACITANCE, which can occur depending on the distance and cable used in the connection to the contactor.

- Connecting the sensor to a contactor in long distances, use resistor:

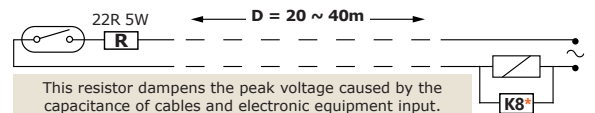

! Important: For distances **greater than 40m**, use 24Vdc voltage.

- Connecting the sensor to an electronic equipment:

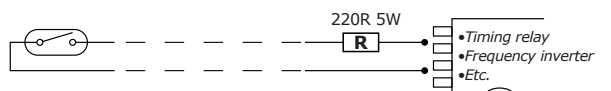

! Important: For installation with **relay coupler**, use 4K7 10W resistor.

Suitable for Detection of Low Flows

Fluid flow through the sensor triggers precise displacement of a magnetic piston acting on an electrical contact (Reed Switch).

Technical Specifications



Model	Actuation range*
FA14B02-M12	From ~0.8 to ~5LPM
FA14B04-M12	From ~1.7 to ~7LPM
FA14B06-M12	From ~2.5 to ~8LPM

* Approximate values with reference in water

Body **PPA (Polyphthalamide)**
 Spring **AISI 304 stainless steel**
 Internal clearance **8mm²**
 Maximum operating pressure **25bar**
 Operating temperature range **0°C to 100°C | 140°C @1h**
 Inlet/outlet port **G 1/4" female (BSP - Parallel)**
 Sealing **NBR (nitrilic rubber) O'Ring**
 Output connection **M12 male plug (2 pins)**
 M12 female connector NOT included
 Enclosure rating **IP66**
 Electrical contact **Reed Switch 20W/VA (NO SPST)**
 Weight **71g**

Installation

- In applications without excessive vibration;
- Minimum distance of 20mm from any ferrous surface;
- Mounting with parallel port connection and O'Ring.

Sealing

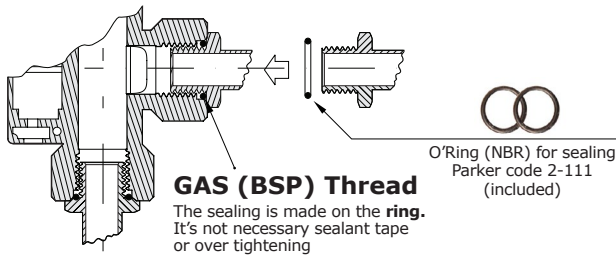

Flow Rate Sensitivity Adjustment



Mounting

Dimensions in millimeters.

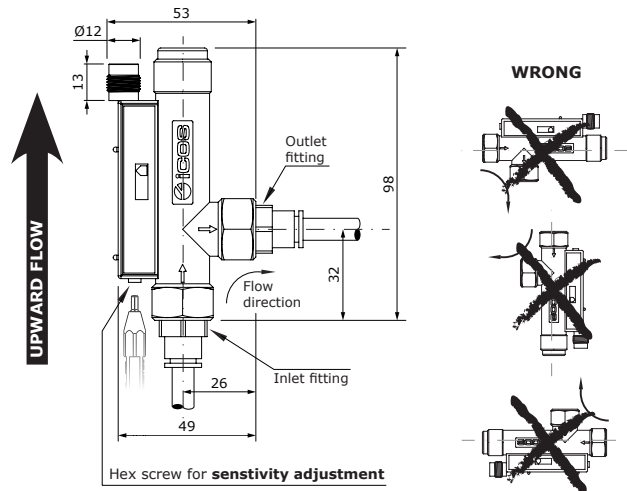

Electrical Connection

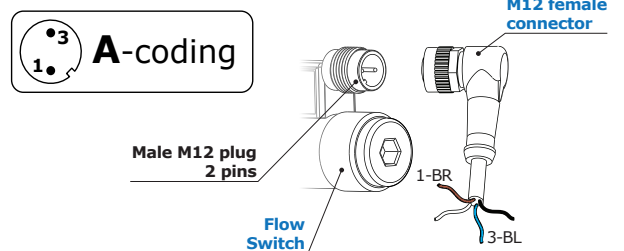

Maintenance

1. Open the plug, remove the spring and clean using a brush if there is encrustation;
2. Mount the sensor again as illustrated beside;
3. Test the electrical contact using an ohmmeter, moving the magnetic piston.

